

MENG366

Introduction to Control System

Dr. Saeed Asiri
saeed@asiri.net

What do these two have in common?



Tornado



Boeing 777

- **Highly nonlinear, complicated dynamics!**
- **Both are capable of transporting goods and people over long distances**

BUT

- **One is controlled, and the other is not.**
- **Control is “the hidden technology that you meet every day”**
- **It heavily relies on the notion of “feedback”**

Basic Concepts of Feedback Control

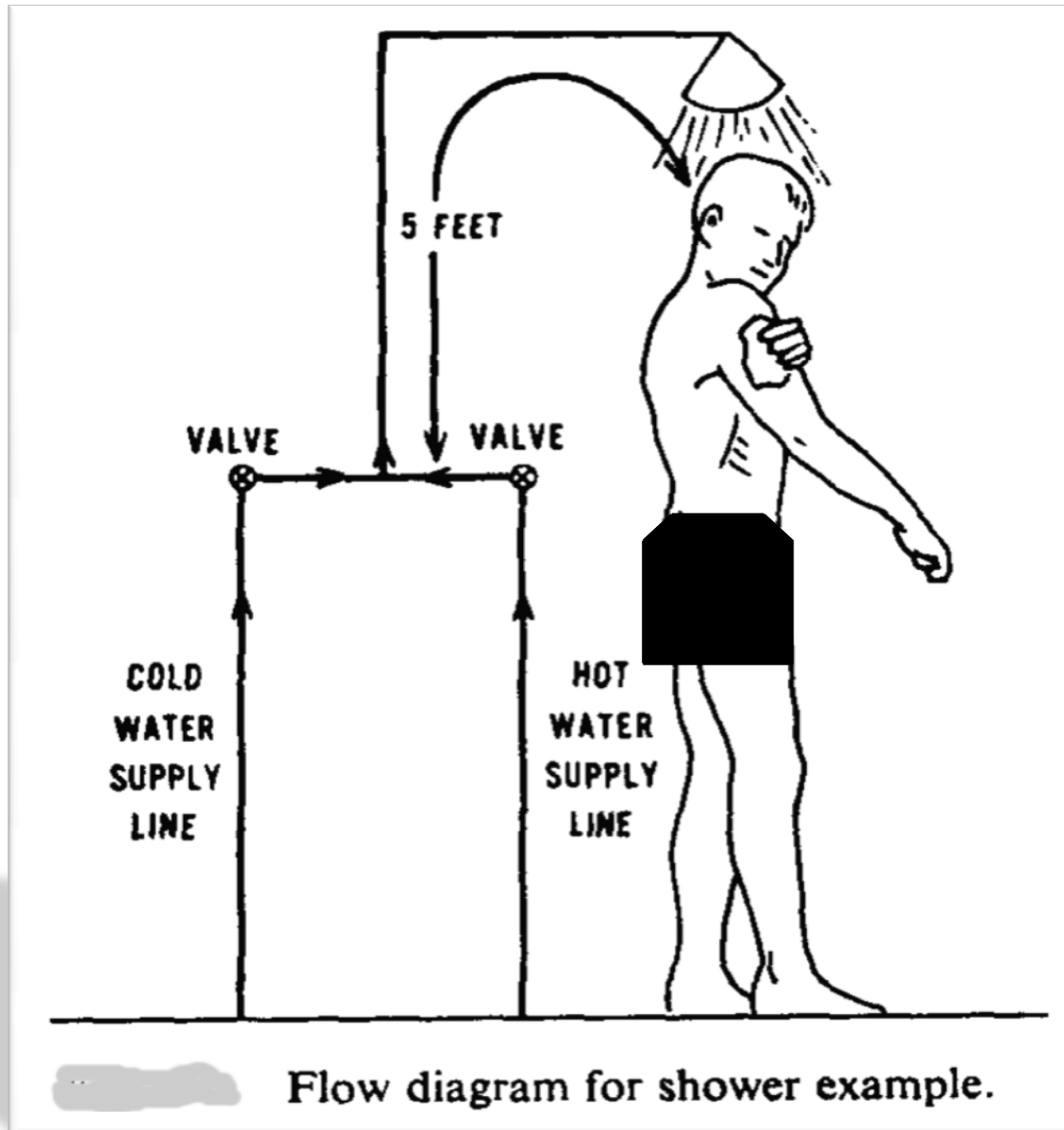

Course Overview

- ▶ One of the most important and multi-disciplinary courses you'll ever take
 - *Physics*
 - *Kinematics*
 - *Mathematics*
 - *Time and frequency response analysis*
 - *Engineering judgment*
- ▶ Leveraging previous coursework and preparing for future coursework
 - *Mechanical vibrations*
 - *Mechanics, electrical, electromechanical*
 - *Fluid-thermal*
 - *Calculus, differential equations, complex algebra*
 - *Measurements/instrumentation understanding*
- ▶ Emphasize combination of theoretical and conceptual understanding

Remember these?



Overview

Example: Vehicle speed control

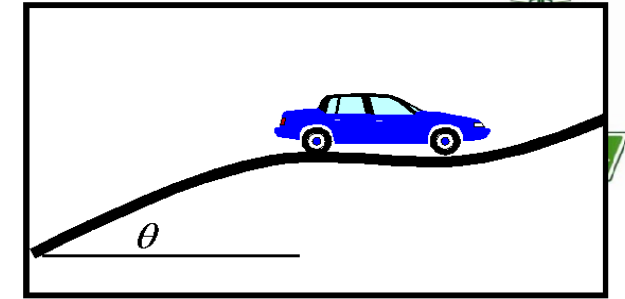

1. MODEL:

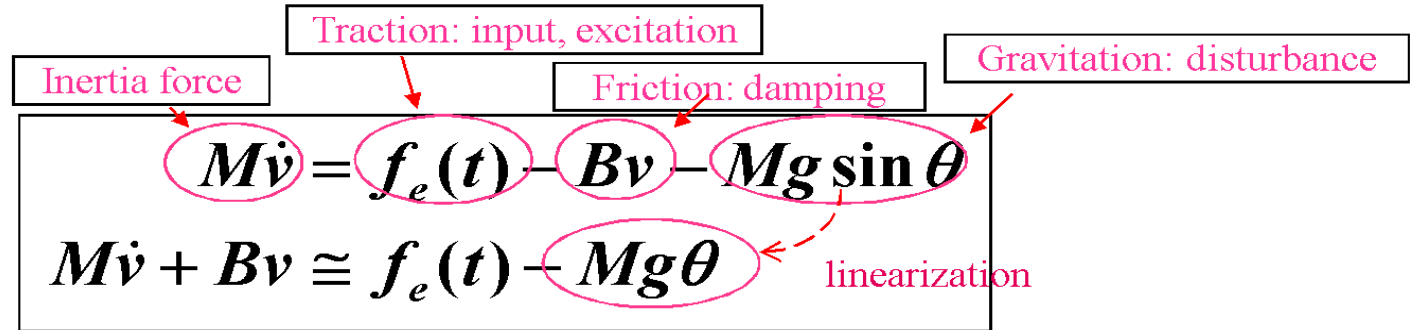

2. ANALYSIS:

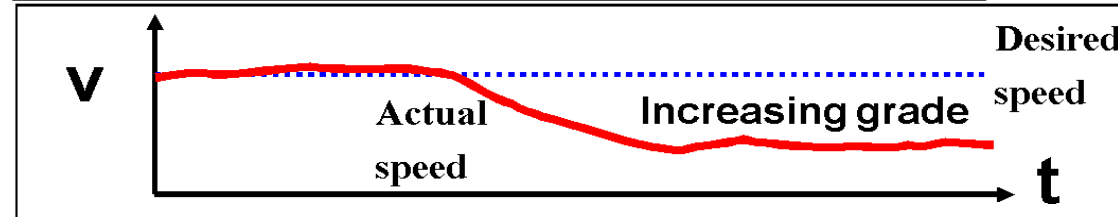

3. CONTROL:

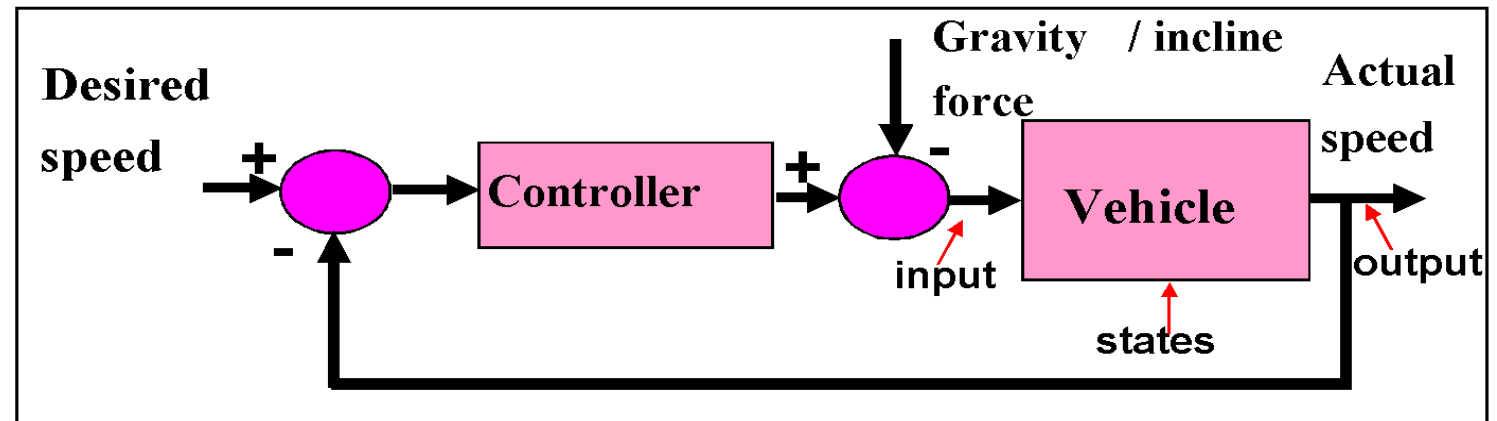

Basic Concepts

▶ System

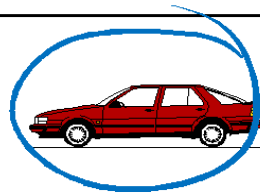

A *combination* of *components* acting together to perform *a specific objective*

▶ Modeling

A procedure to obtain a *model* describing *important* characteristics of system

▶ Analysis

Investigation of *performance* of system, whose model is *known*, under specified conditions

Motivation for MENG366

Why should we care about modeling and analysis?

Explaining interesting Phenomenon



Component and Machine Design



Feedback Control Design and Adding Intelligence



Definitions Related to System



- ▶ **Input** *A variable that excites a system*
 - *Inputs are not always known beforehand*
 - *Inputs are always responsible for problems in systems*

- ▶ **Output** *A variable that we observe and consider important*
 - *Measurements/instrumentation*
 - *Not necessary what we want to know*

- ▶ **State** *A variable that is used to describes the internal system dynamics*
 - *A set of states can be used to fully describe system's current situation.*
 - *With two identical sets of initial values of states, performance of a system is the same*
 - *Do you get all the states of system ?*

Interdisciplinary and System Nature of MENG366

Analogous systems

► **Models are the same regardless of the physical domain of interest**

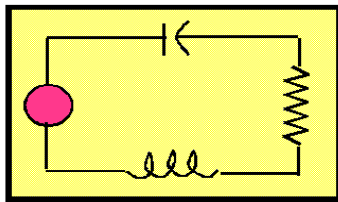

$y = \text{Charge}$
 $u = \text{Voltage}$

=

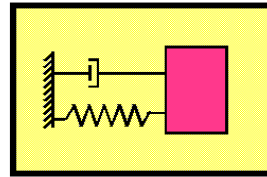

$y = \text{Transl. displ.}$
 $u = \text{Force}$

=

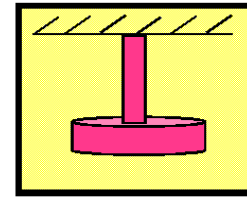

$y = \text{Angular displ.}$
 $u = \text{Torque}$

=

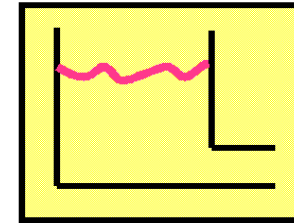

$y = \text{Volume}$
 $u = \text{Pressure}$



► **We only need to understand how to analyze one model, but the results are applicable for four seemingly different types of physical systems!**

Big Picture

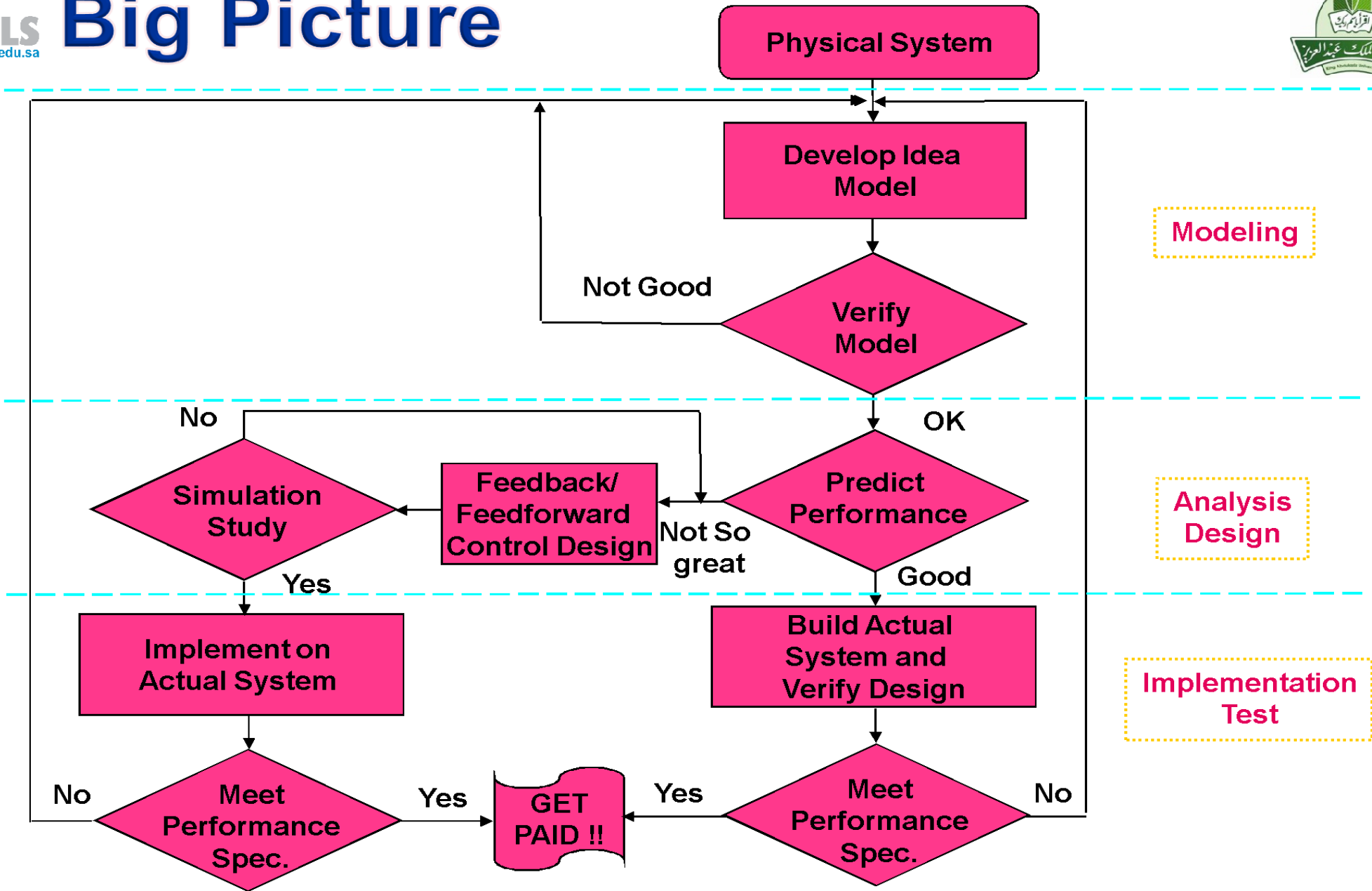

Response: Input vs. Output



Input and output
(an elevator case)

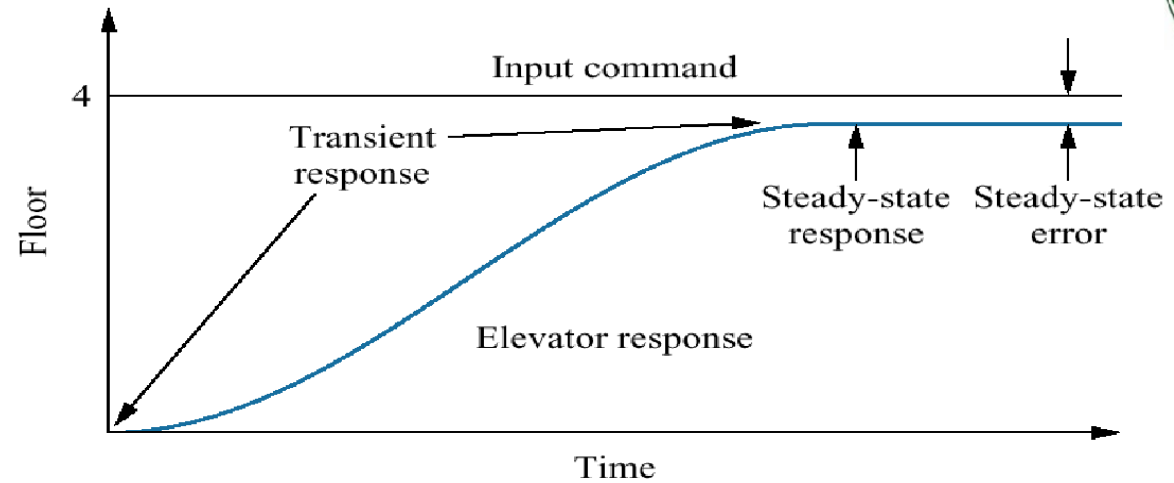

Response of a general
position control system
showing effect of high and
low controller gain on the
output response

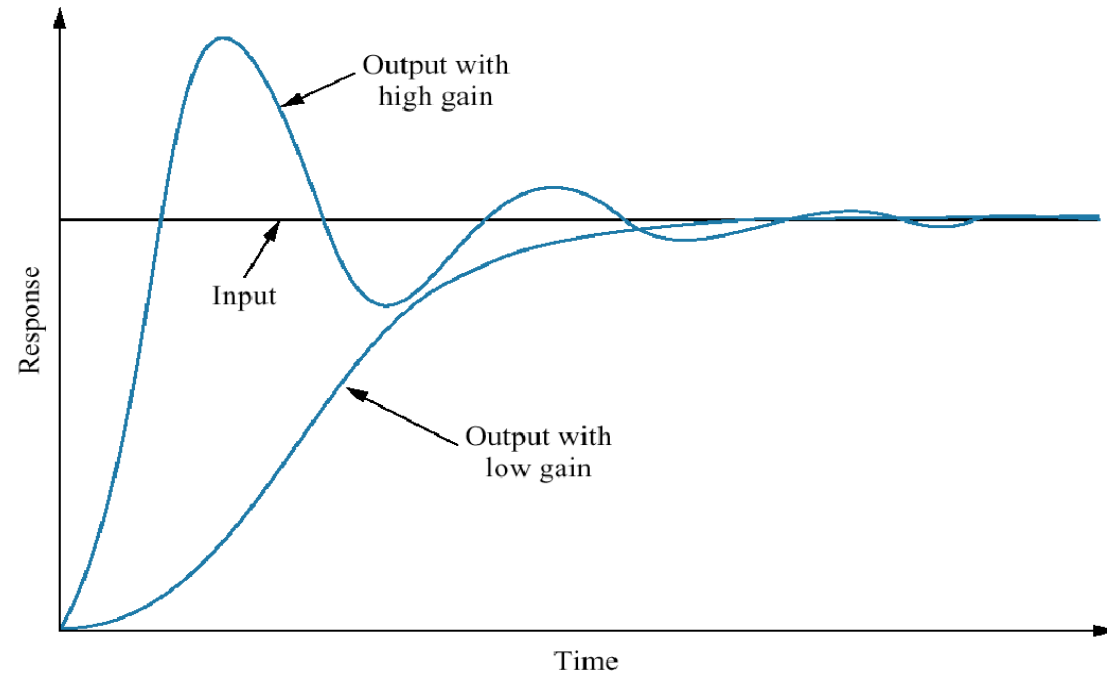

Two Types of Control Systems

- **Open Loop**
 - No feedback
 - Difficult to control output with accuracy
- **Closed Loop**
 - Must have feedback
 - **Must have sensor on output**
 - Almost always negative feedback

Open-loop vs. Closed-loop

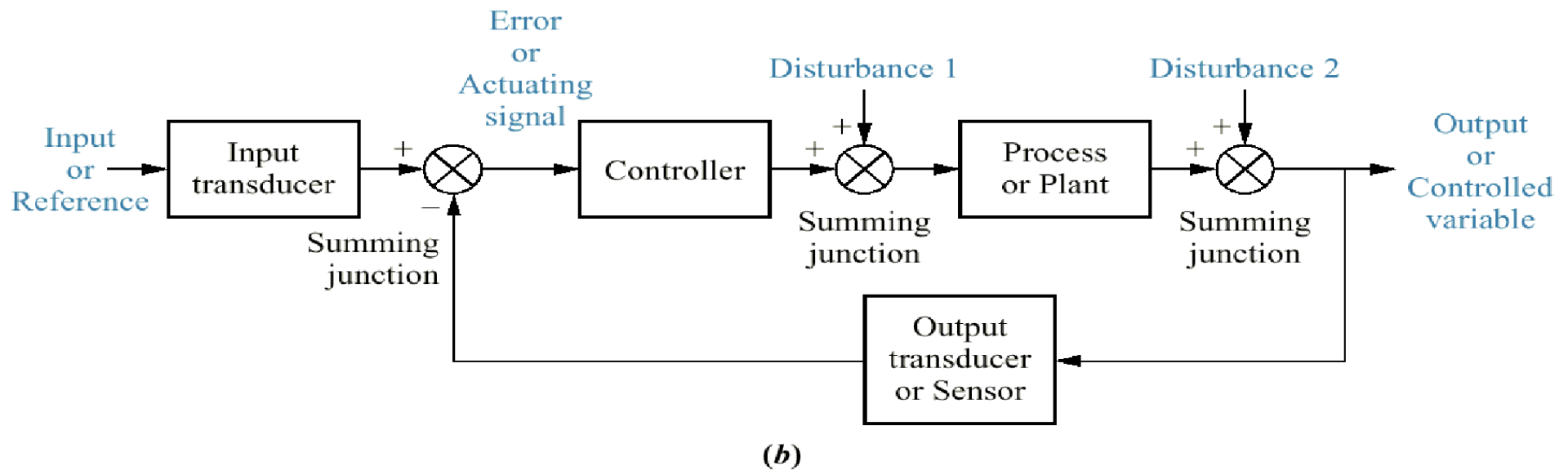
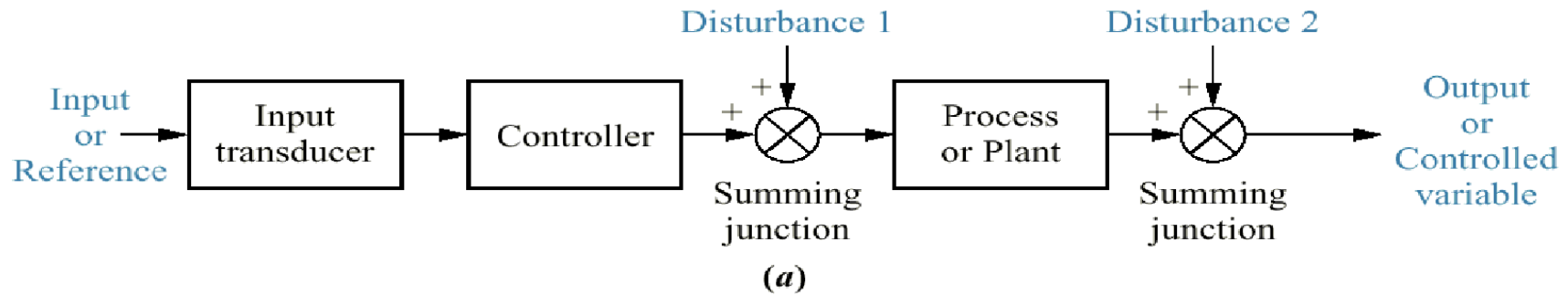

Open-Loop vs Closed-Loop

- Closed-Loop (Feedback) Control**

The control input $u(t)$ (or $U(s)$) is synthesized based on the a priori knowledge of the system (plant), the reference input $r(t)$ (or $R(s)$) and the measurement of the actual output $y(t)$ (or $Y(s)$). For example the temperature control of this classroom:

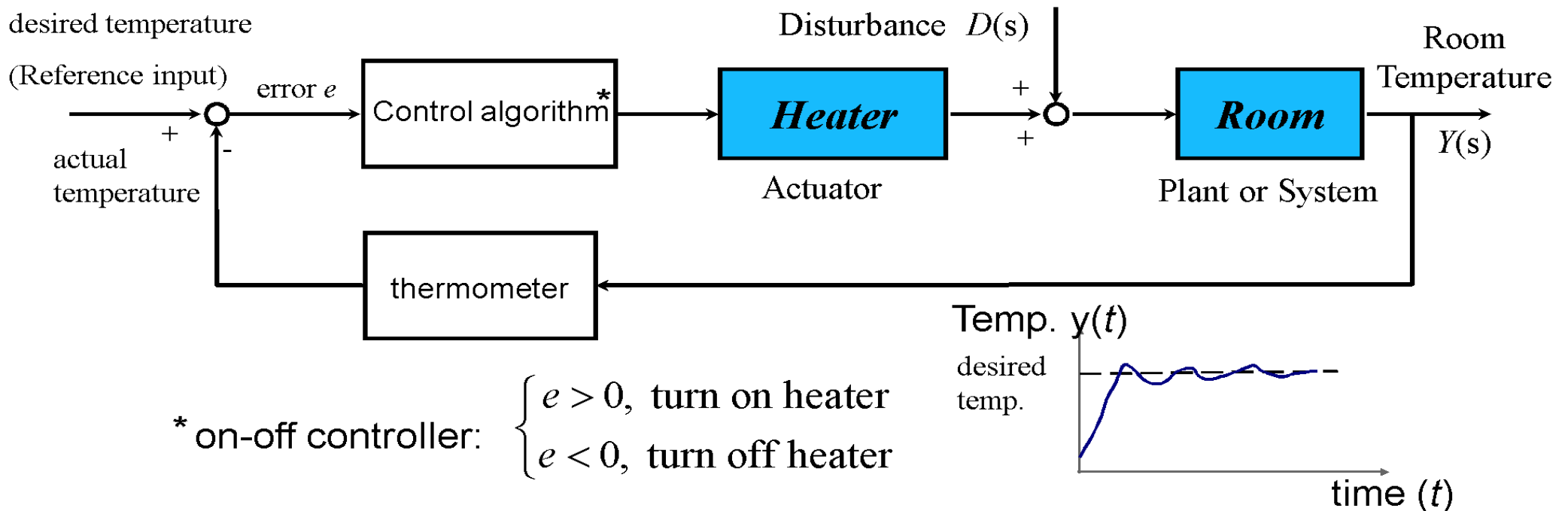

Open-loop control

An open-loop control system utilizes an actuating device to control the process directly without using feedback.

A common example of an open-loop control system is an electric toaster in the kitchen.

Open-loop control

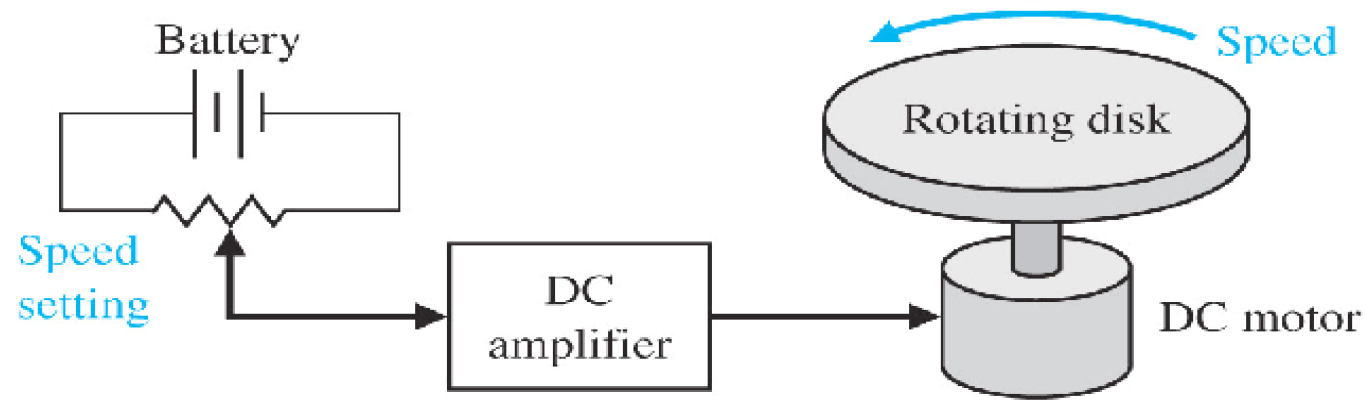

(a)

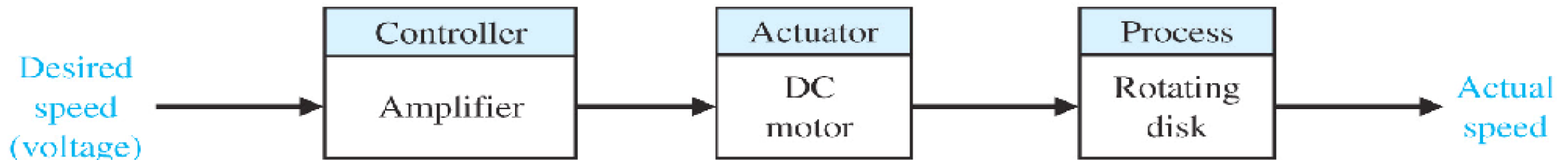

(b)

Closed-loop control

A closed-loop control system uses a measurement of the output and feedback of this signal to compare it with the desired output.

Negative Feedback Control System

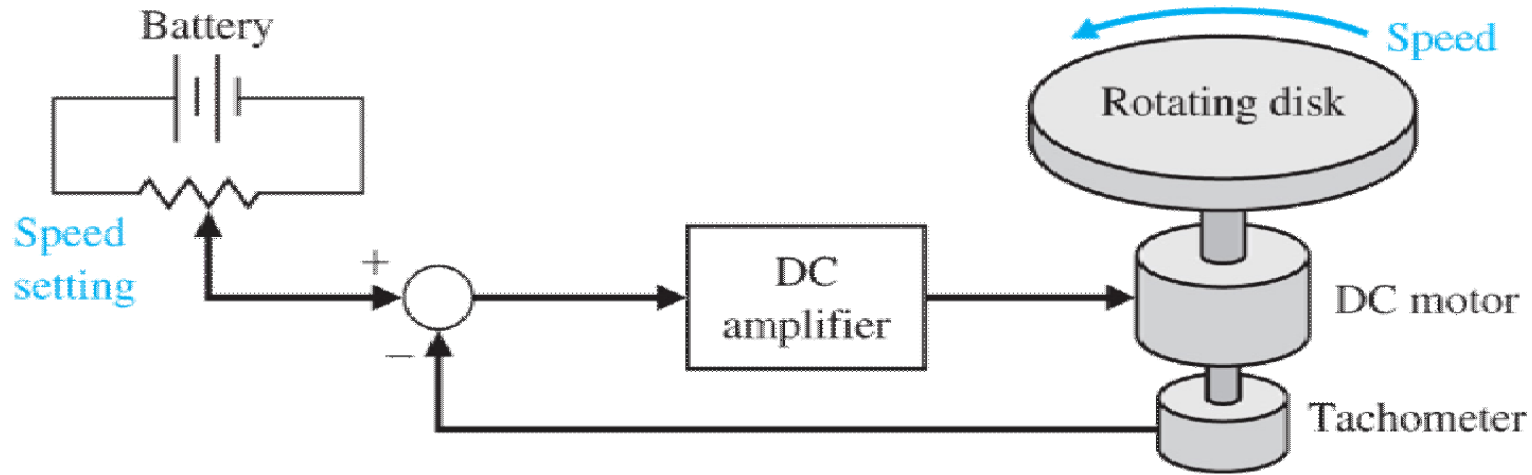

(a)

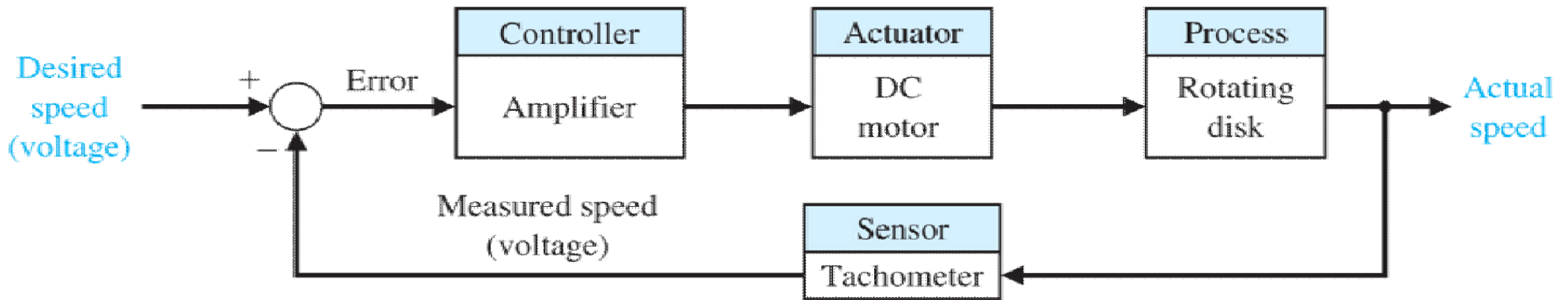

(b)

Closed-loop control

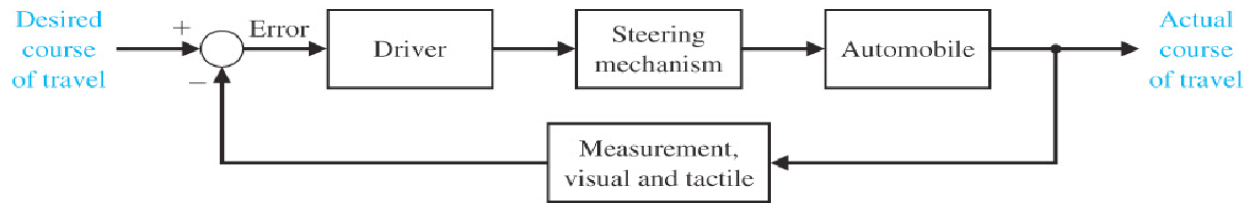

(a)

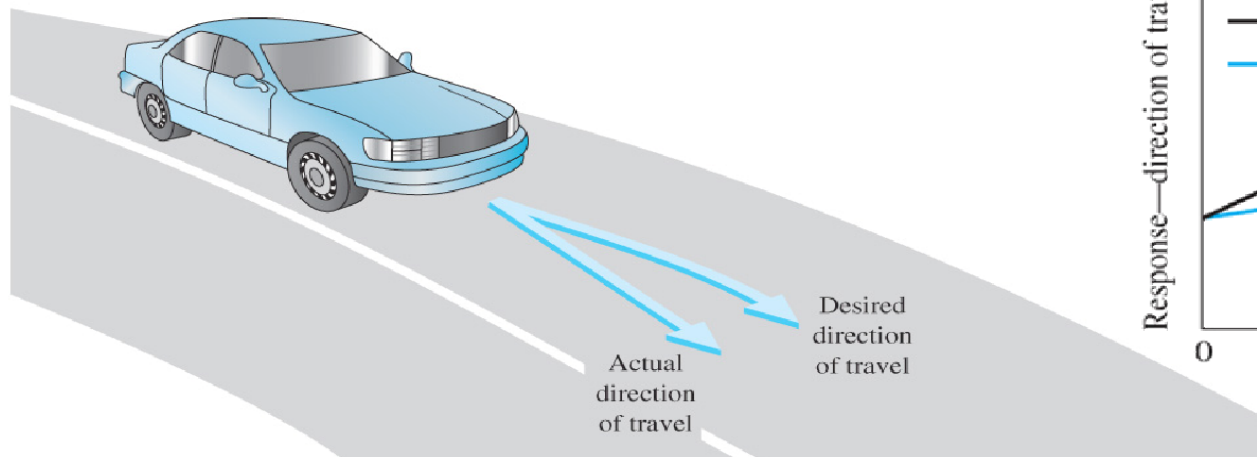

(b)

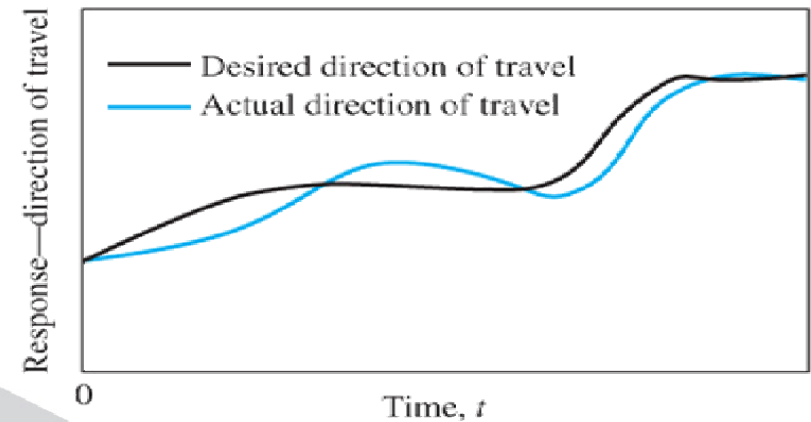

A person steering an automobile by looking at the auto's location on the road and making the appropriate adjustments.

Closed-loop control

Control = Sensing + Computation + Actuation

In Feedback “Loop”



- Goals

- Stability: system maintains desired operating point (hold steady speed)
- Performance: system responds rapidly to changes (accelerate to 65 mph)
- Robustness: system tolerates perturbations in dynamics (mass, drag, etc)

Manual control system

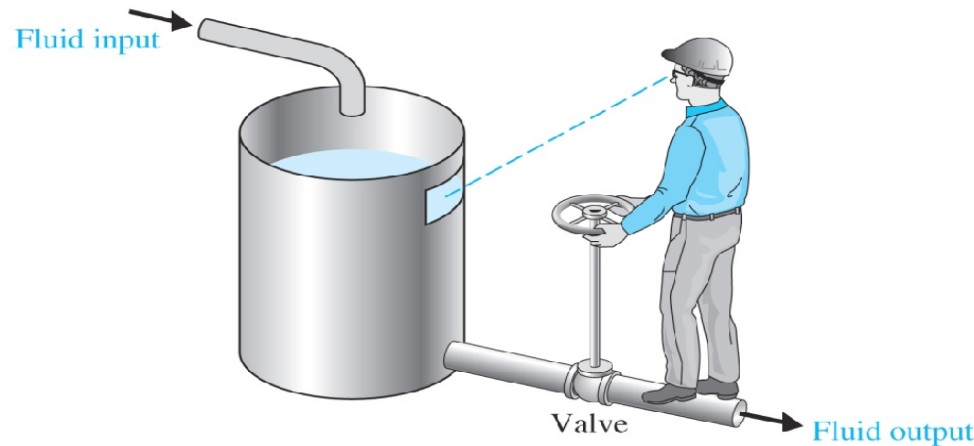

Figure: 01-08

Copyright © 2008 Pearson Prentice Hall, Inc.

Goal: Regulate the level of fluid by adjusting the output valve.

The input is a reference level of fluid and is memorized by operator.

The power amplifier is the operator.

The sensor is visual.

Operator compares the actual level with the desired level and opens or closes the valve (actuator).

The level of fluid in a tank control

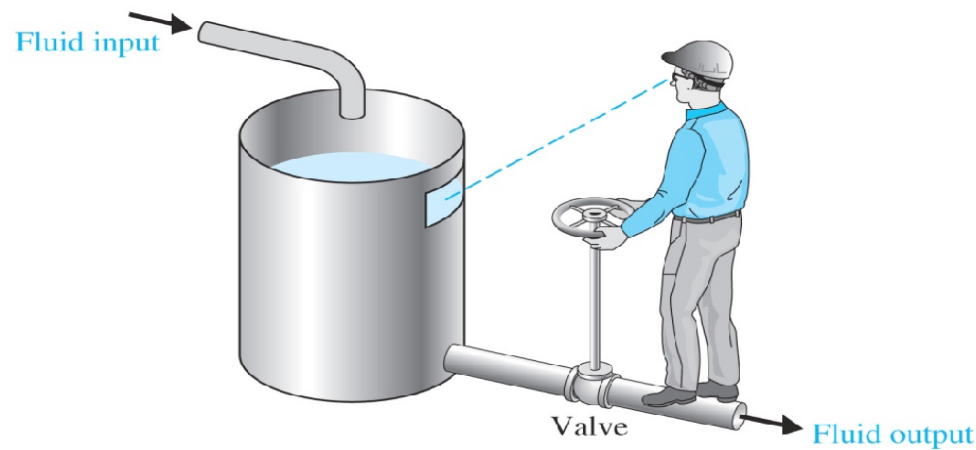
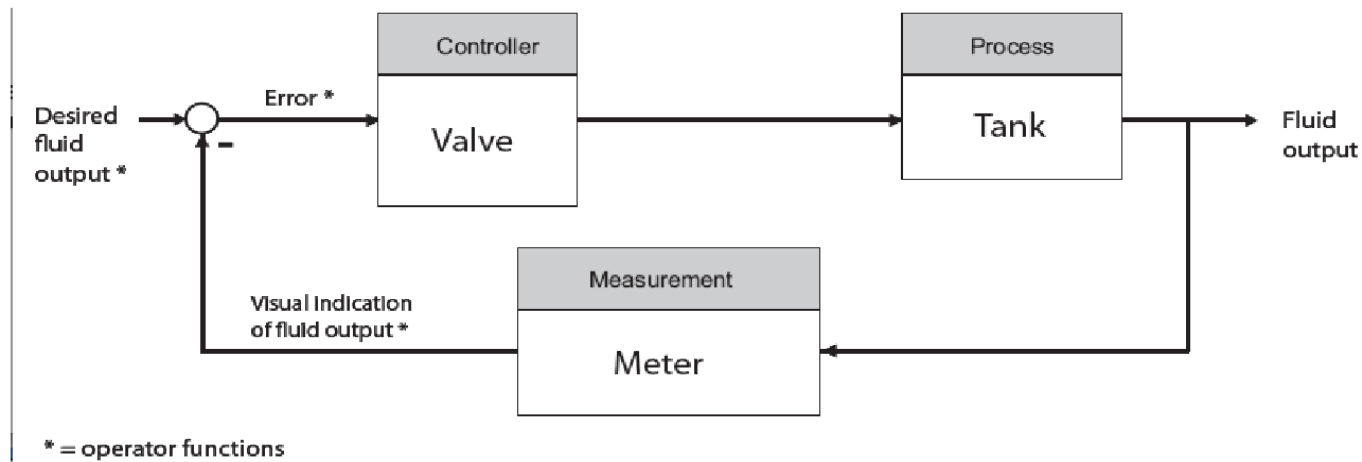

Figure 01-08

Copyright © 2008 Pearson Prentice Hall, Inc.



Multivariable control system

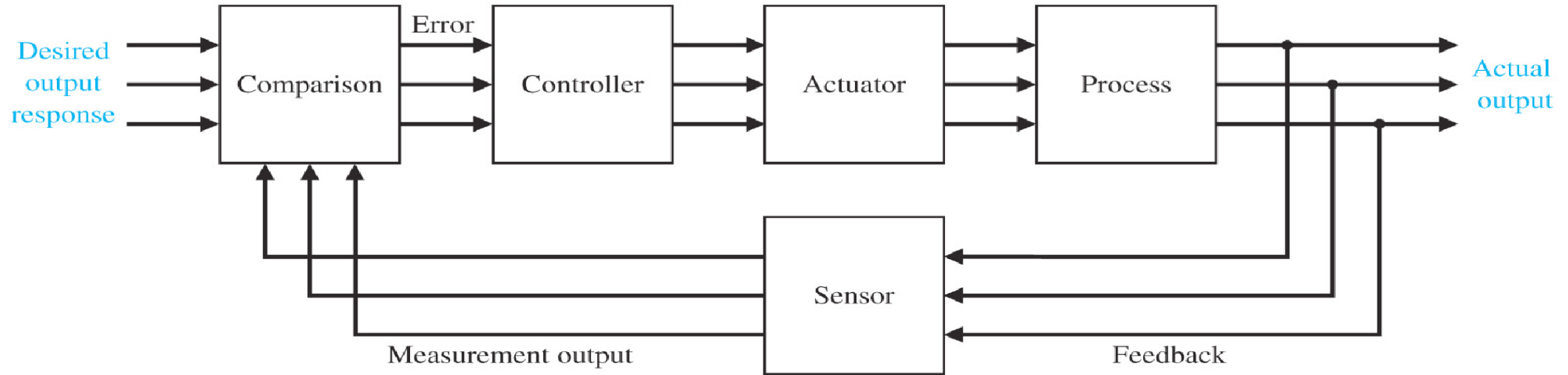
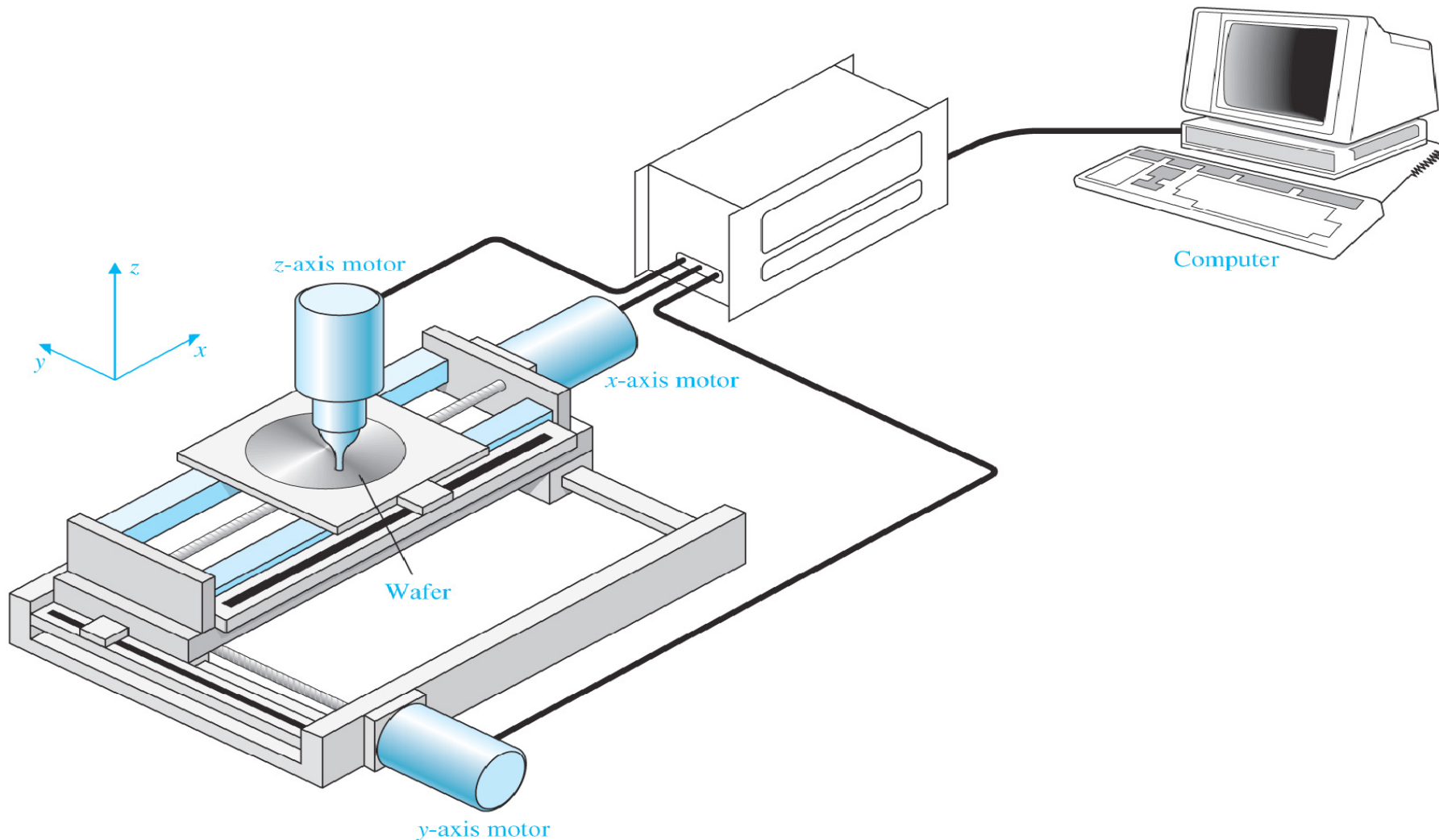

Figure: 01-04

Copyright © 2008 Pearson Prentice Hall, Inc.

Closed-loop control



A three-axis control system for inspecting individual semiconductor wafers with a highly sensitive camera.

Multivariable control system

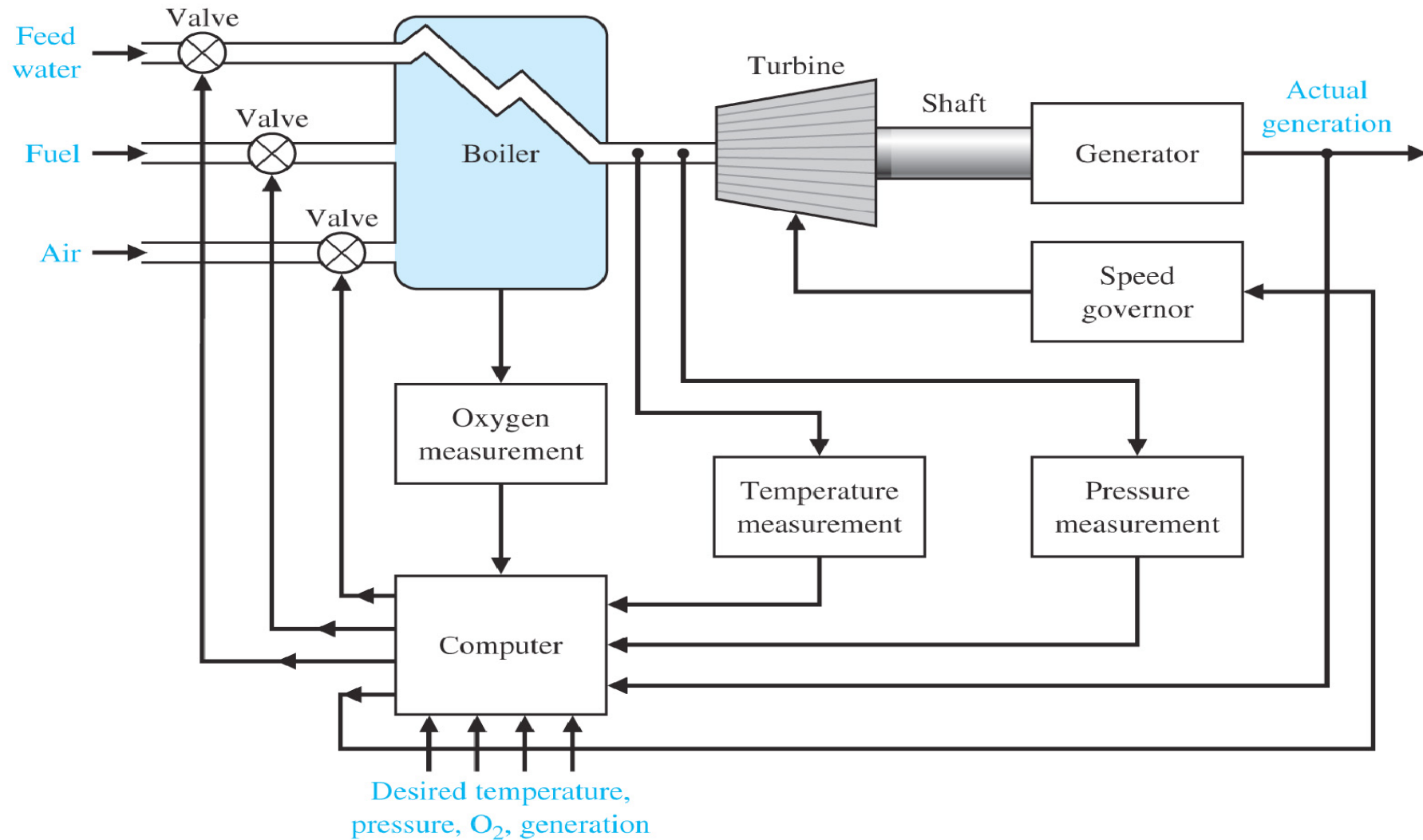

Coordinated control system for a boiler-generator

Control system of the national income

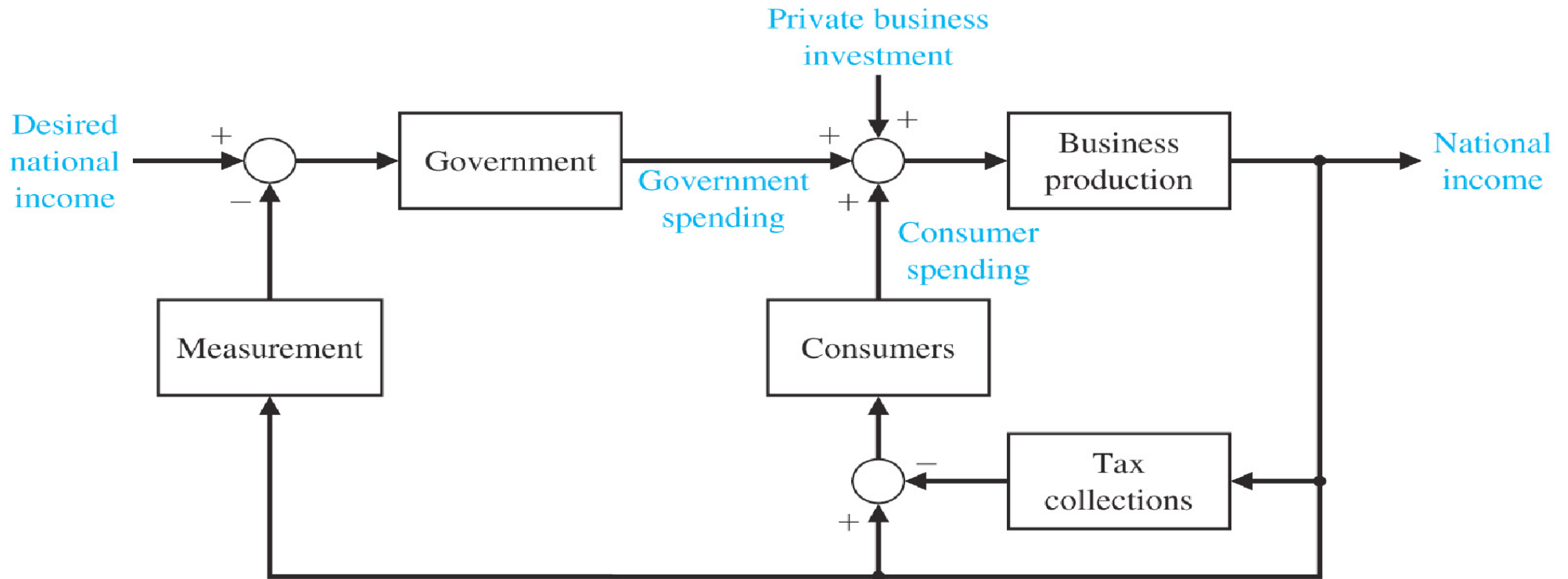

Figure: 01-13

Copyright © 2008 Pearson Prentice Hall, Inc.

Closed-loop control

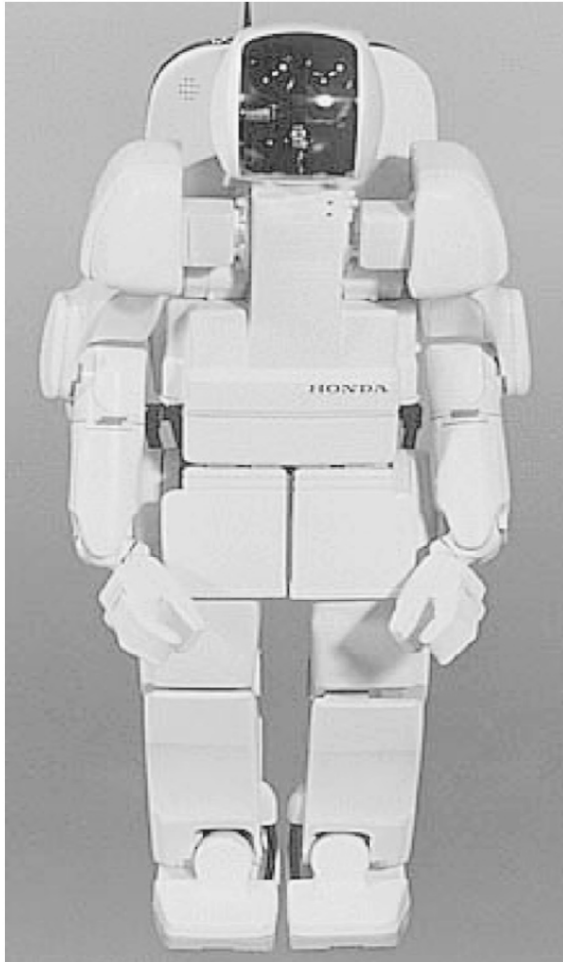

Figure: 01-09

Copyright © 2008 Pearson Prentice Hall, Inc.

A robot is a computer-controlled machine.

Industrial robotics is a particular field of automation in which the robot is designed to substitute for human labor.

The Honda P3 humanoid robot.

The blood glucose and insulin concentrations for a healthy person

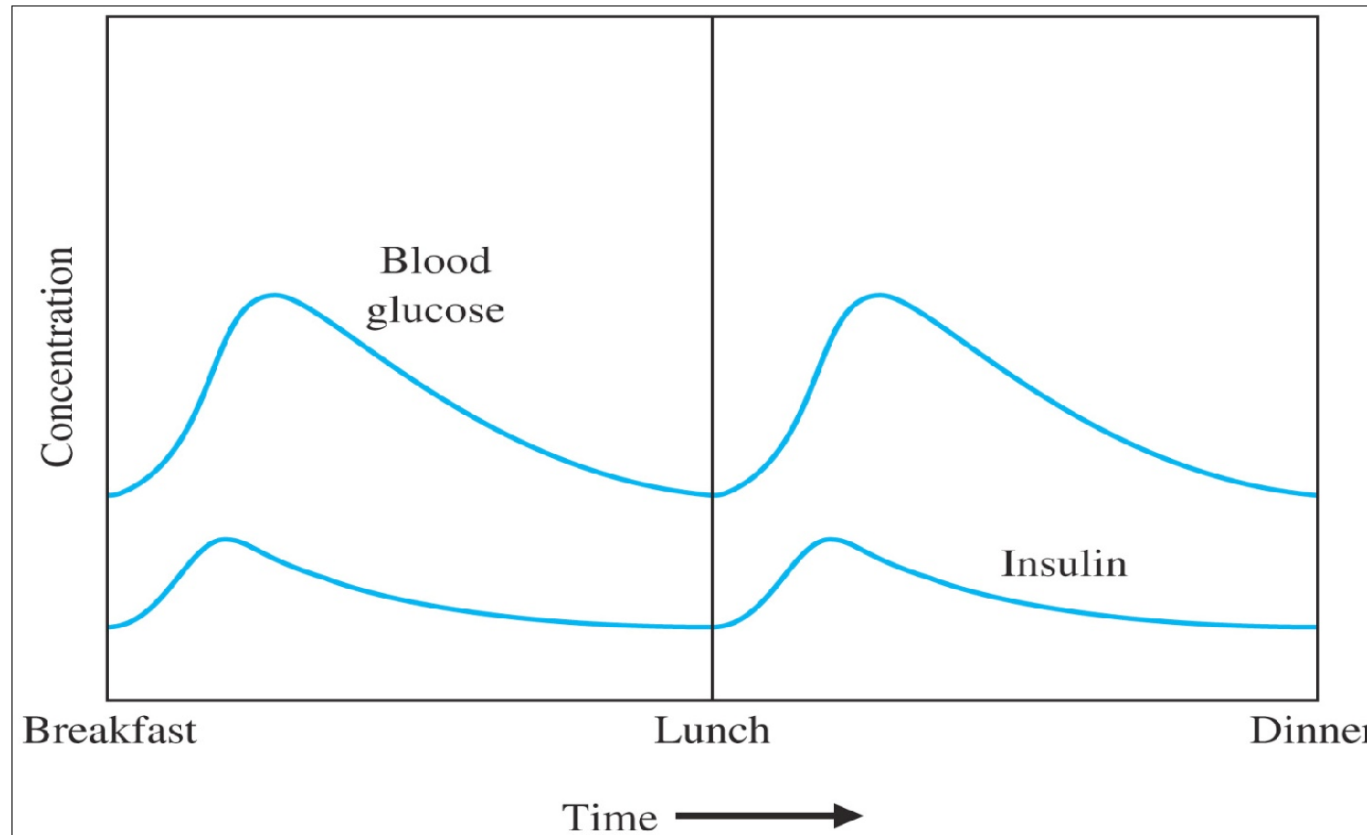

Automatic system can be used to regulate blood pressure, blood sugar level, and heart rate.

Closed-loop Artificial Pancreas

glucose
setpoint

r



controller

u

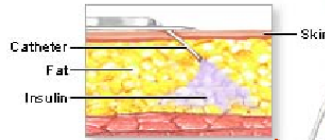

An insulin pump administers insulin through a catheter in the abdominal fat to help control a person's blood sugar levels

Insulin pump



adam.com

pump patient



sensor

y

measured glucose

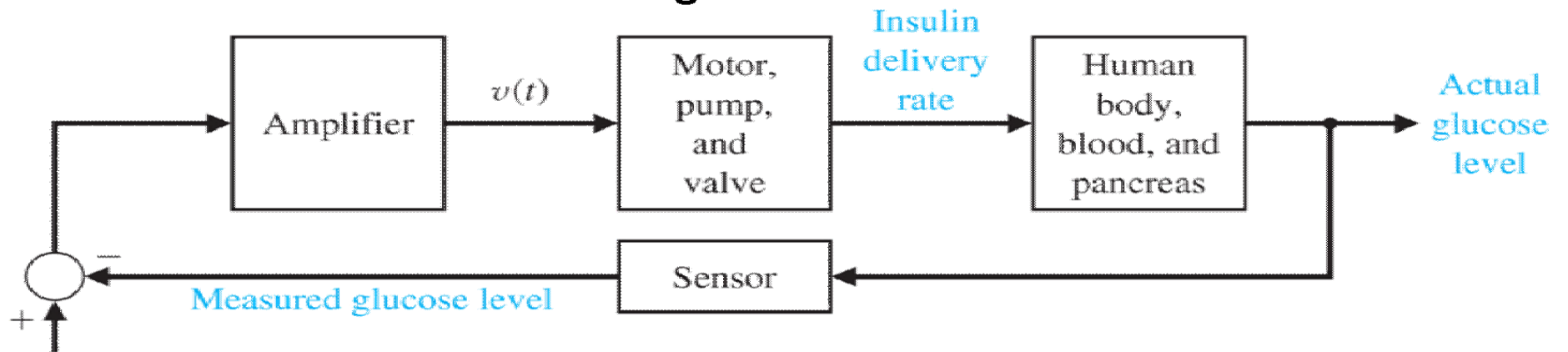

Desired glucose level

A position open loop control

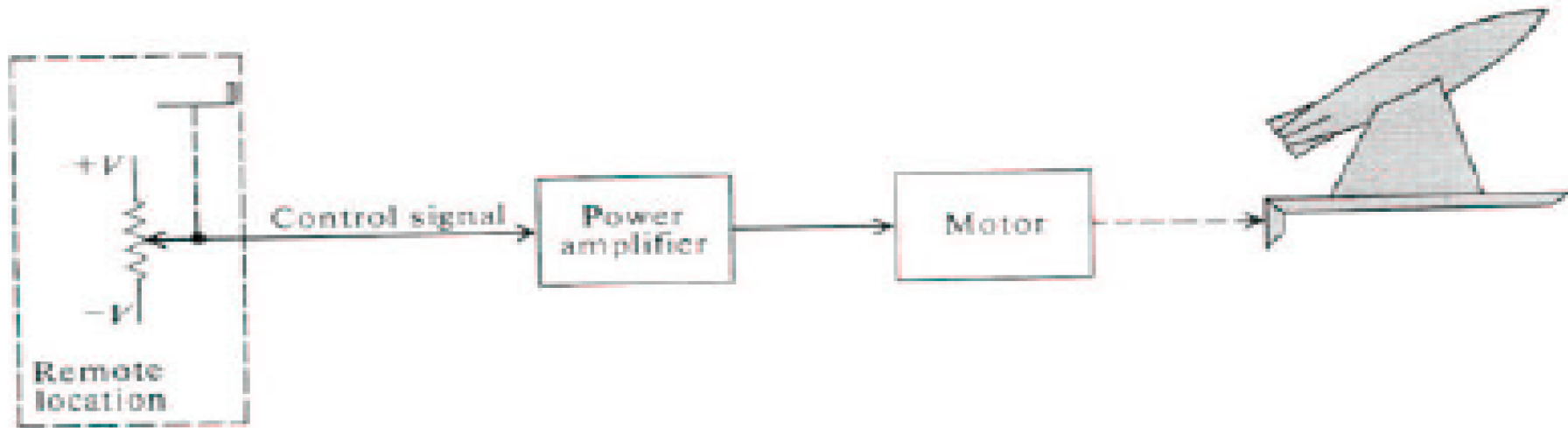

The input is the desired angular position of the missile launcher, and the control system consists of potentiometer, power amplifier, motor, gearing between the motor and missile launcher, and missile launcher.

A position closed loop control

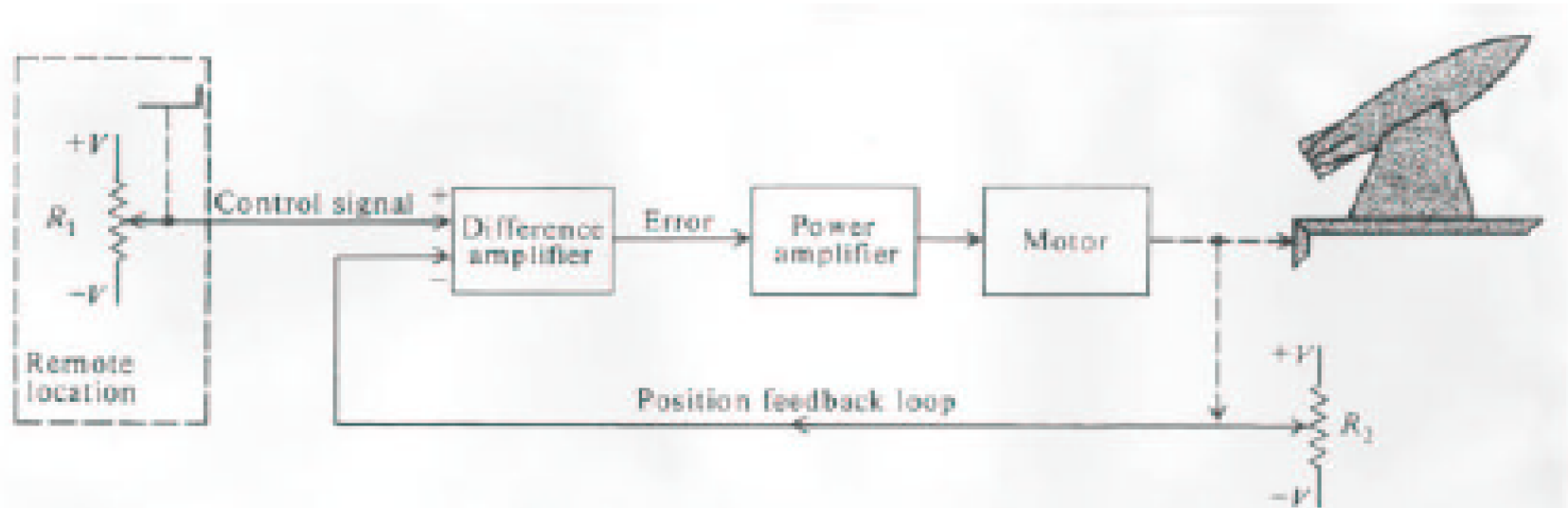

Should an error exists, it is amplified and applied to a motor drive which adjusts the output-shaft position until it agrees with the input-shaft position, and the error is zero.

Chemical composition control

In a chemical process control system, it is valuable to control the chemical composition of the product. To do so, a measurement of the composition can be obtained by using an infrared stream analyzer, as shown in Figure P1.3. The valve on the additive stream may be controlled.

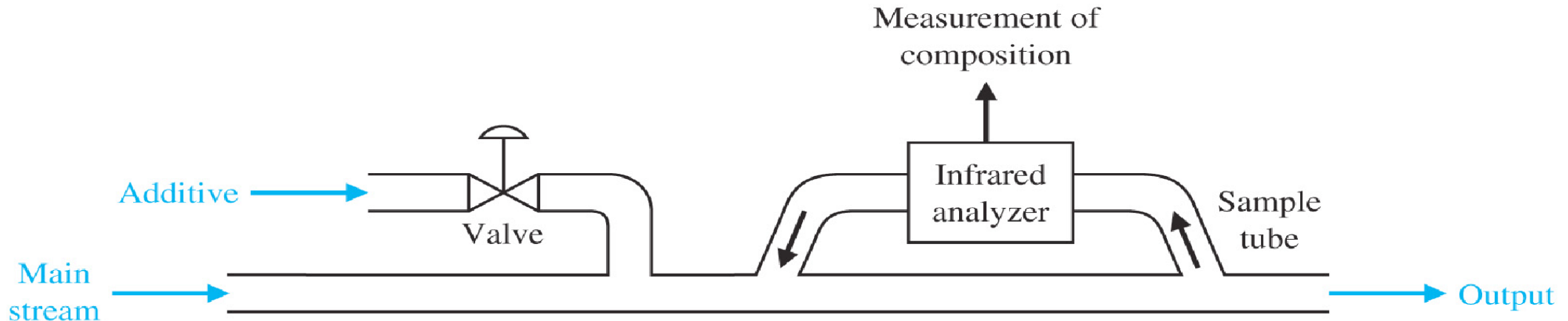
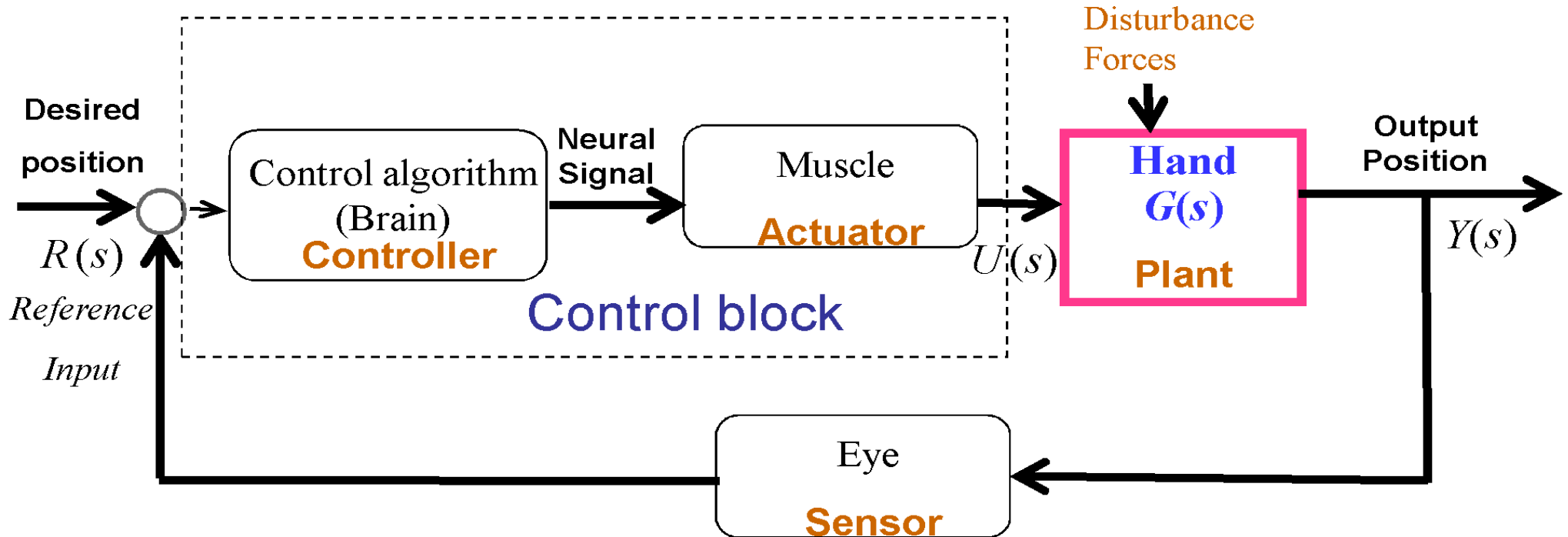

Figure: 01-27-04UNP1.3

Copyright © 2008 Pearson Prentice Hall, Inc.

Control System of Human Body



Open loop

No Feedback

Closed loop

With Feedback

Student-teacher learning process

- **Construct a feedback model of the learning process and identify each block of the system.**

Student-teacher learning process

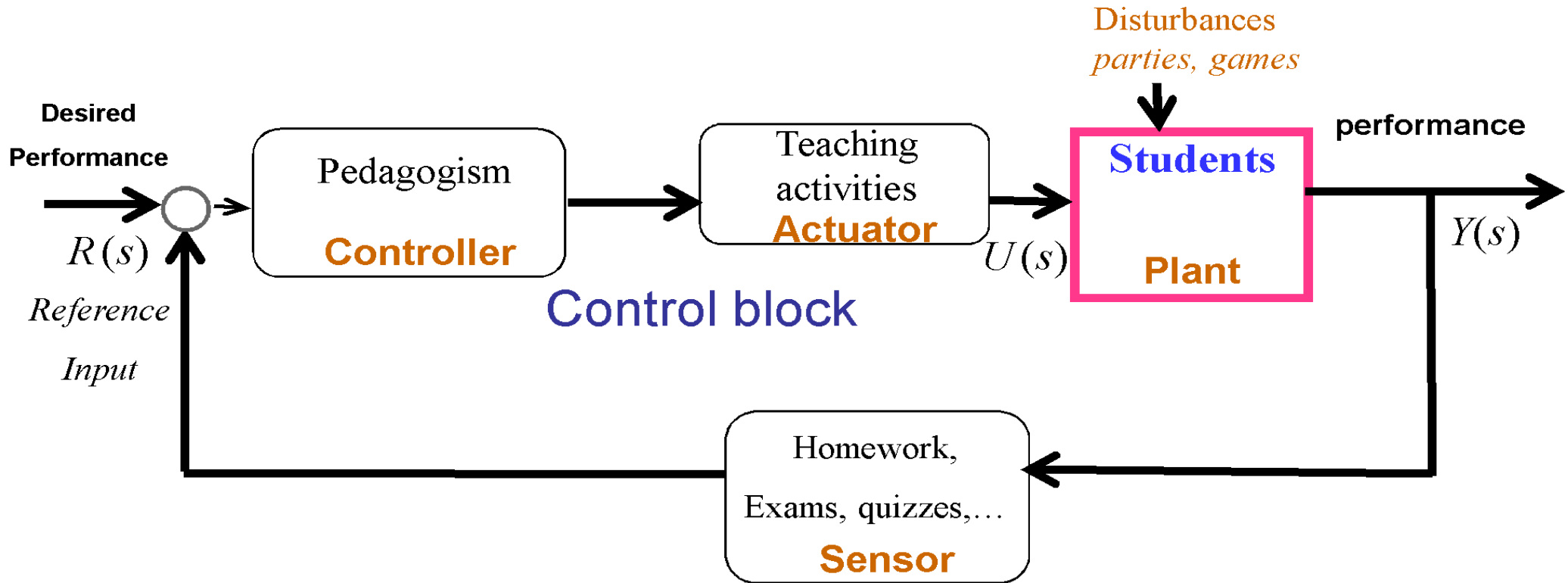

Open loop No Feedback *Blindly teaching ?!*

Closed loop With Feedback

Heater

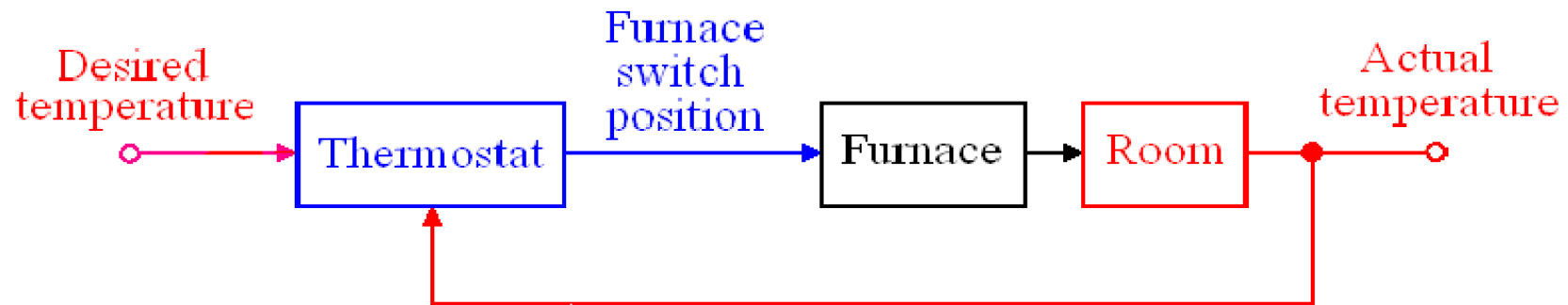

Question: Identify:

- a) the process,
- b) the control input variable,
- c) the output variable,
- d) the controller.

Cruise Control

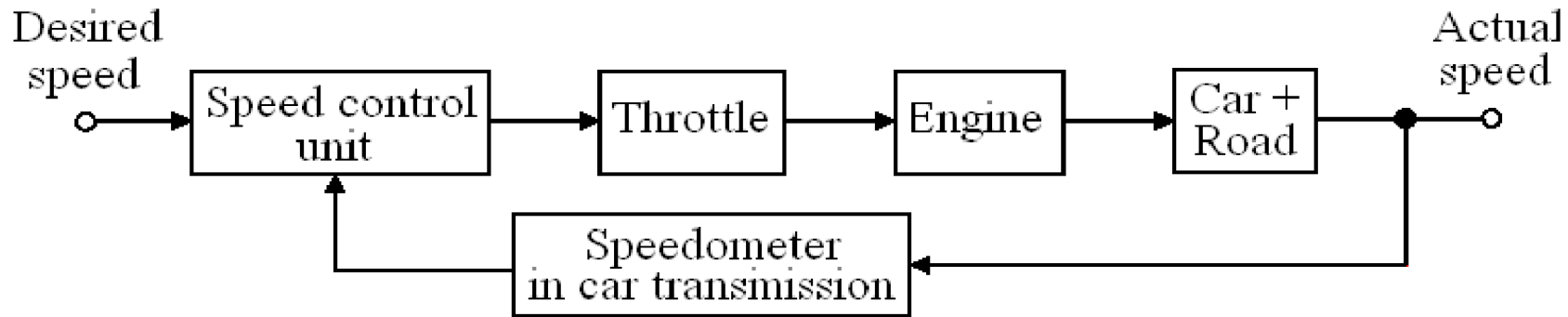

Question: Identify:

- a) the process,
- b) the control input variable,
- c) the output variable,
- d) the controller.

Control System of Fluid Valve

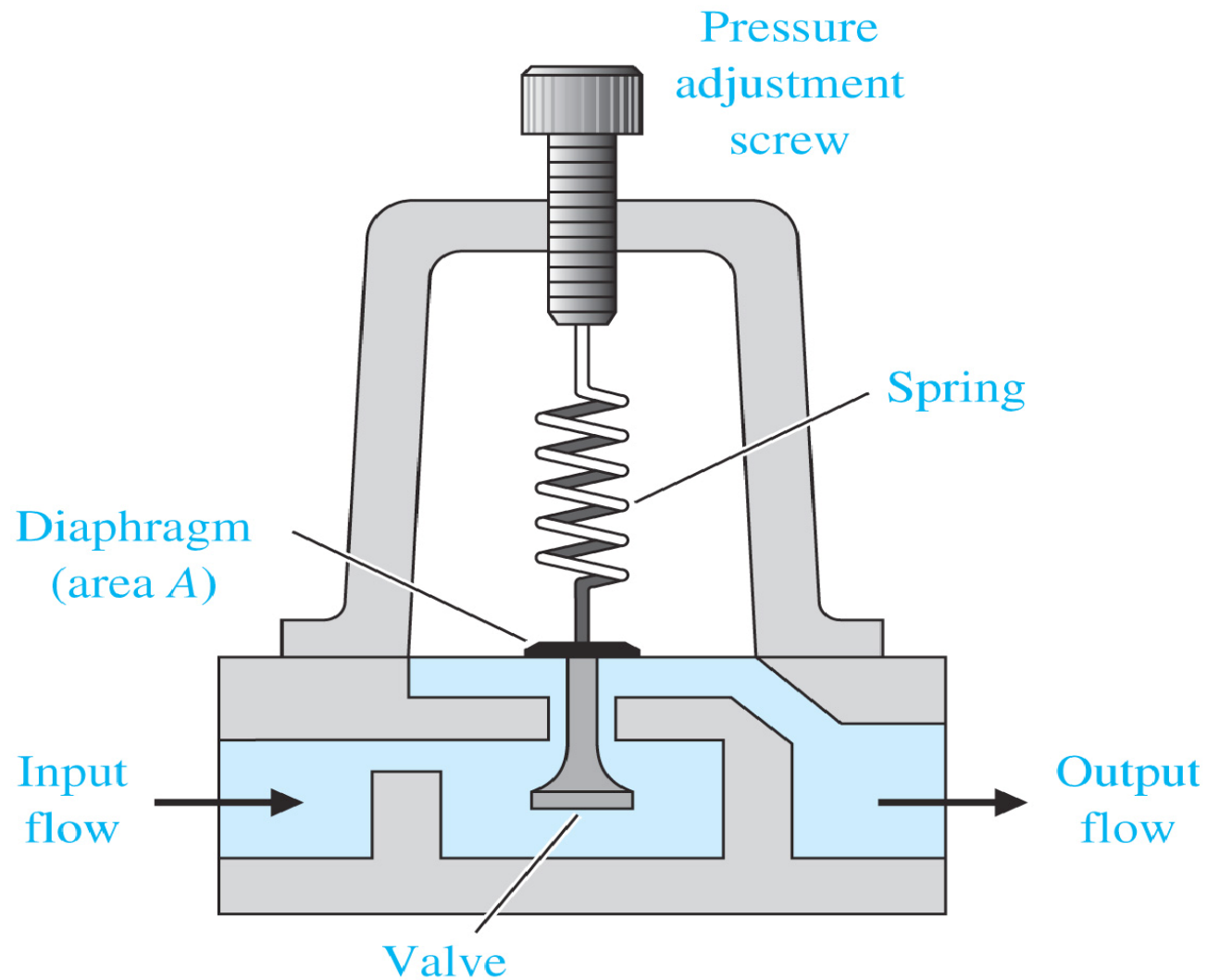
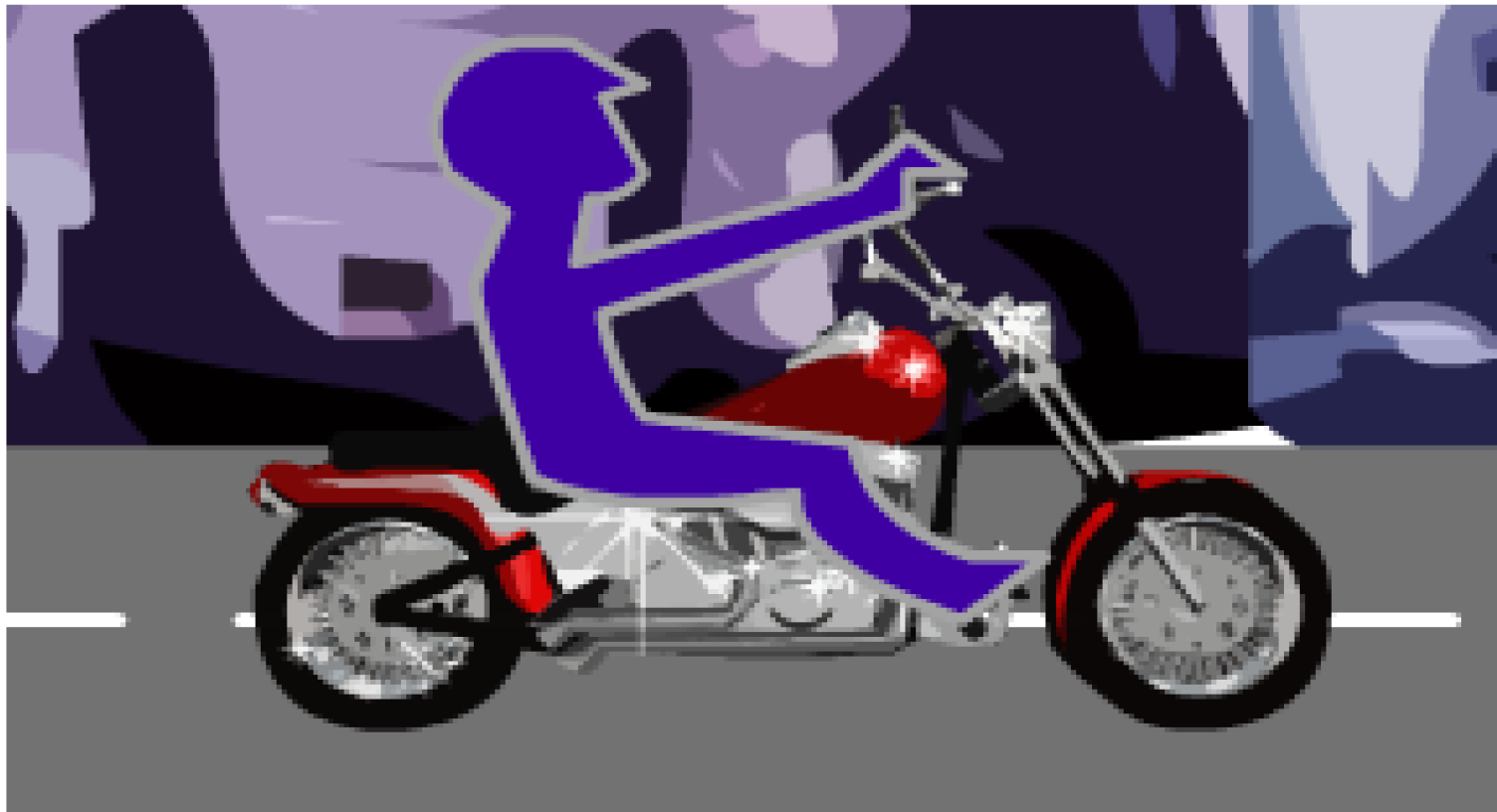

Figure: 01-27-11UNP1.18

Copyright © 2008 Pearson Prentice Hall, Inc.

Volume Control of Motorcycle



Volume Control of Motorcycle

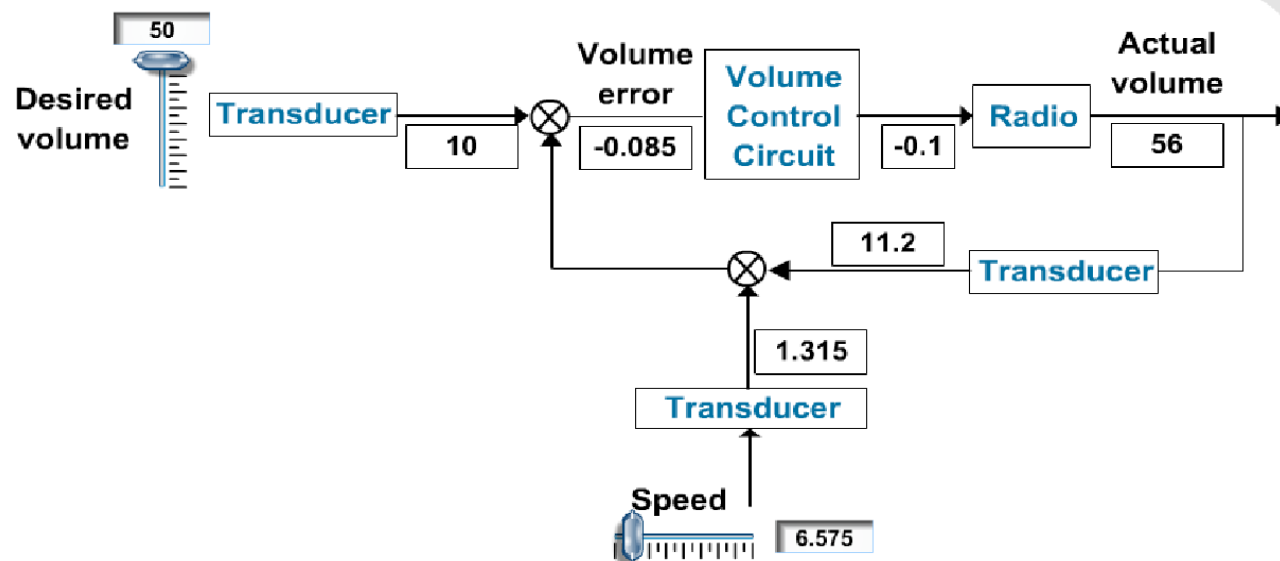

Block Diagram